

**Type ARB; Smin/Std**  
(Aseptic Screw Connection, Female)  
DIN 11864-1 / 11853-1

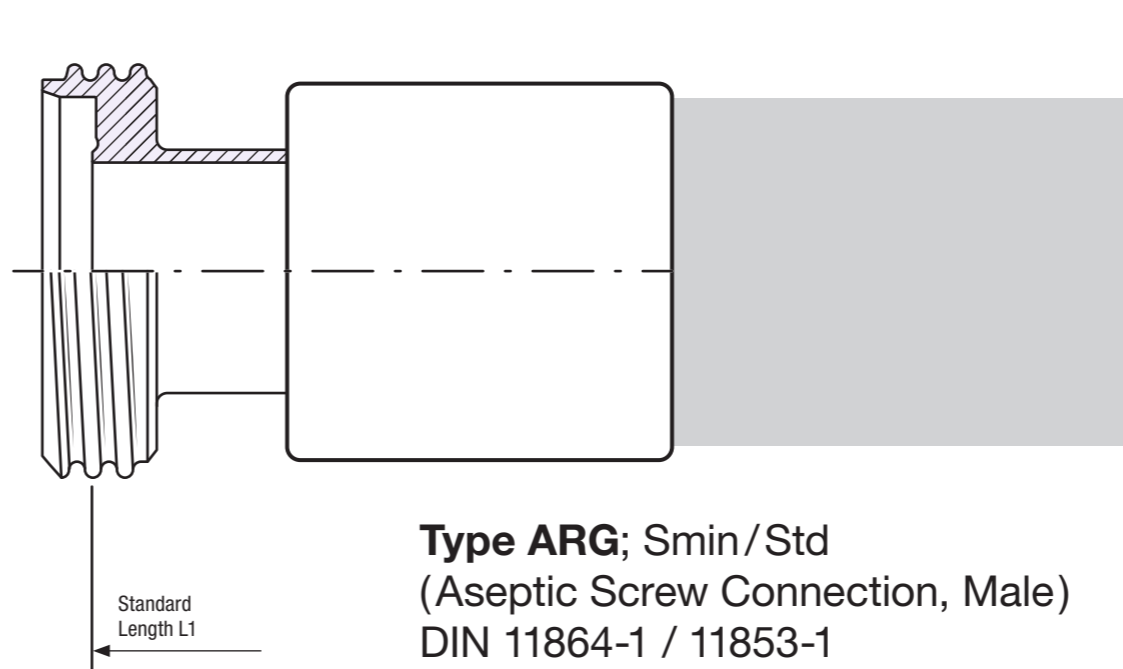

**Type ARG; Smin/Std**  
(Aseptic Screw Connection, Male)  
DIN 11864-1 / 11853-1

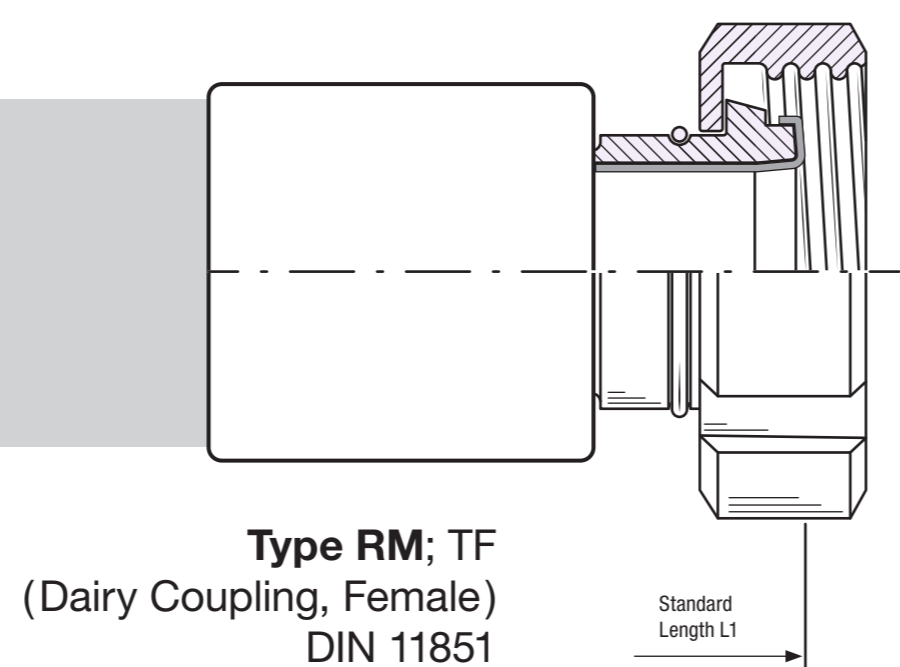

**Type RM; TF**  
(Dairy Coupling, Female)  
DIN 11851

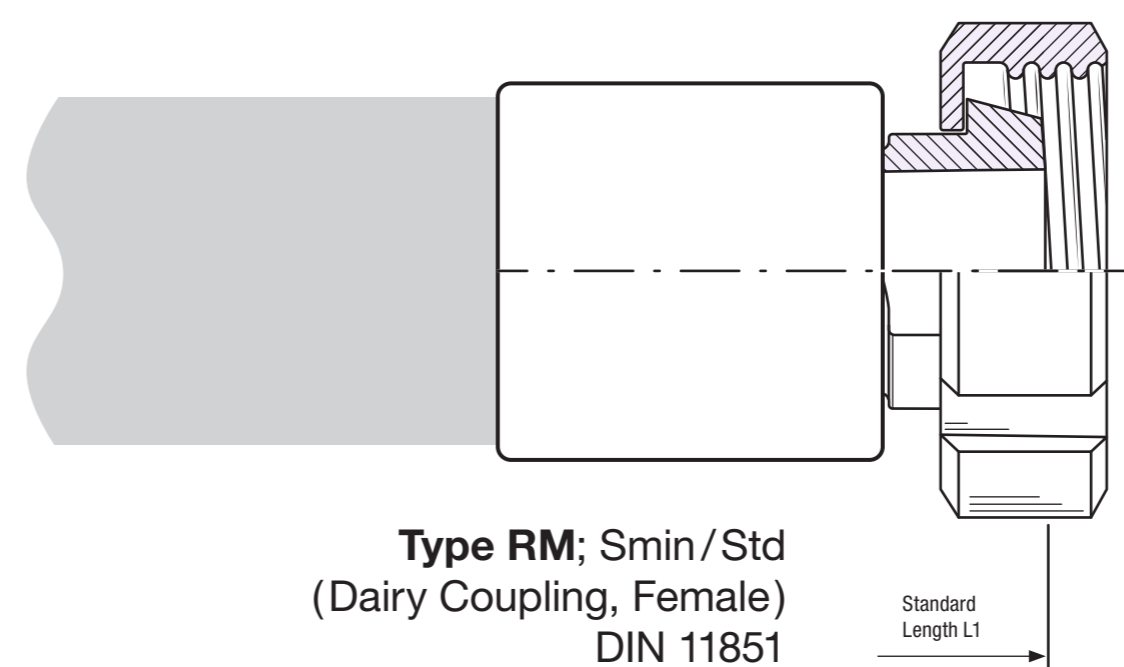

**Type RM; Smin/Std**  
(Dairy Coupling, Female)  
DIN 11851

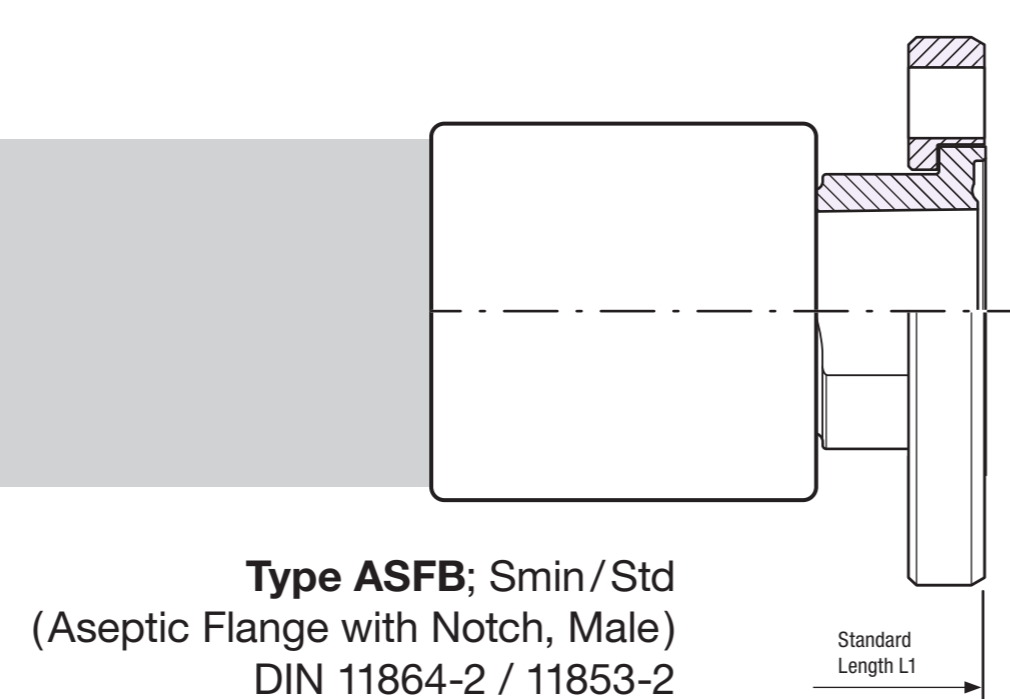

**Type ASFB; Smin/Std**  
(Aseptic Flange with Notch, Male)  
DIN 11864-2 / 11853-2

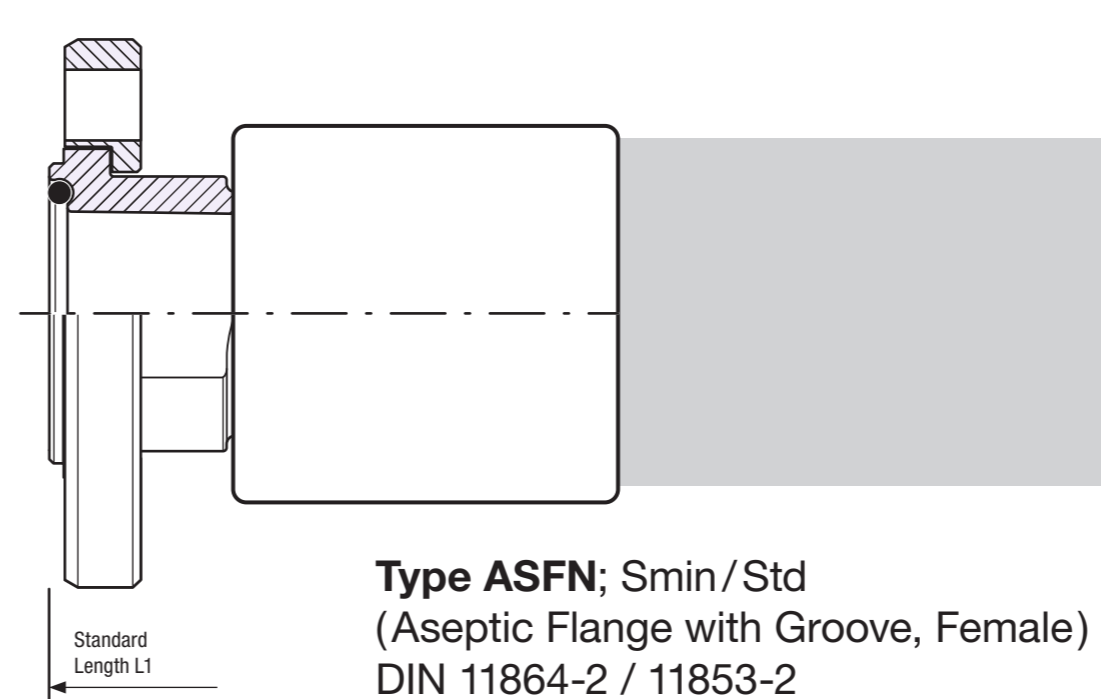

**Type ASFN; Smin/Std**  
(Aseptic Flange with Groove, Female)  
DIN 11864-2 / 11853-2

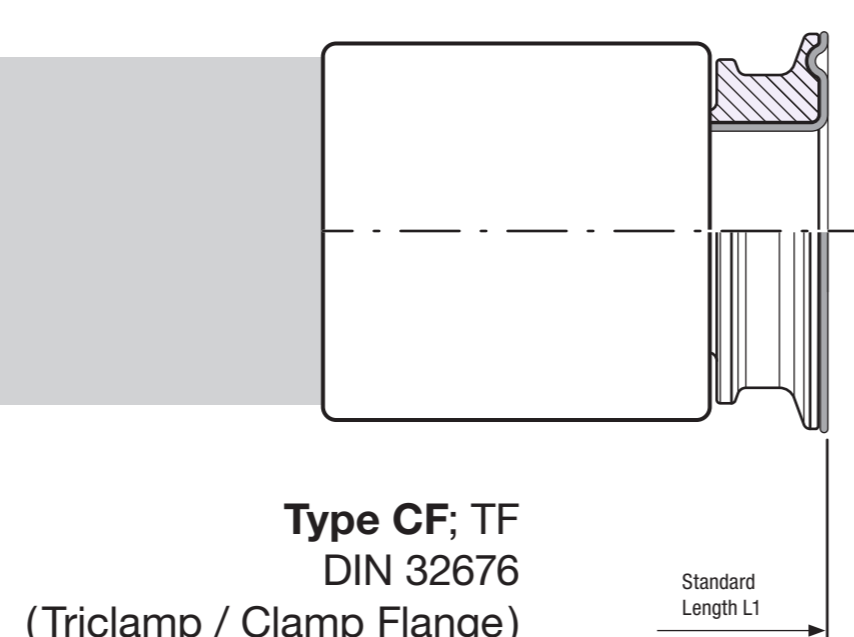

**Type CF; TF**  
DIN 32676  
(Triclamp / Clamp Flange)

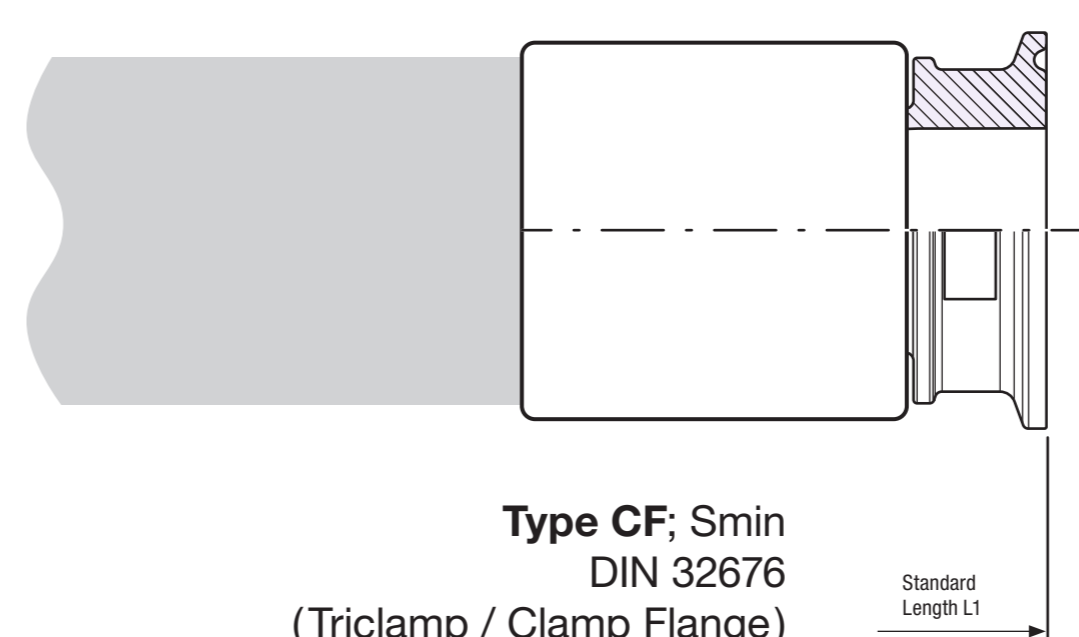

**Type CF; Smin**  
DIN 32676  
(Triclamp / Clamp Flange)

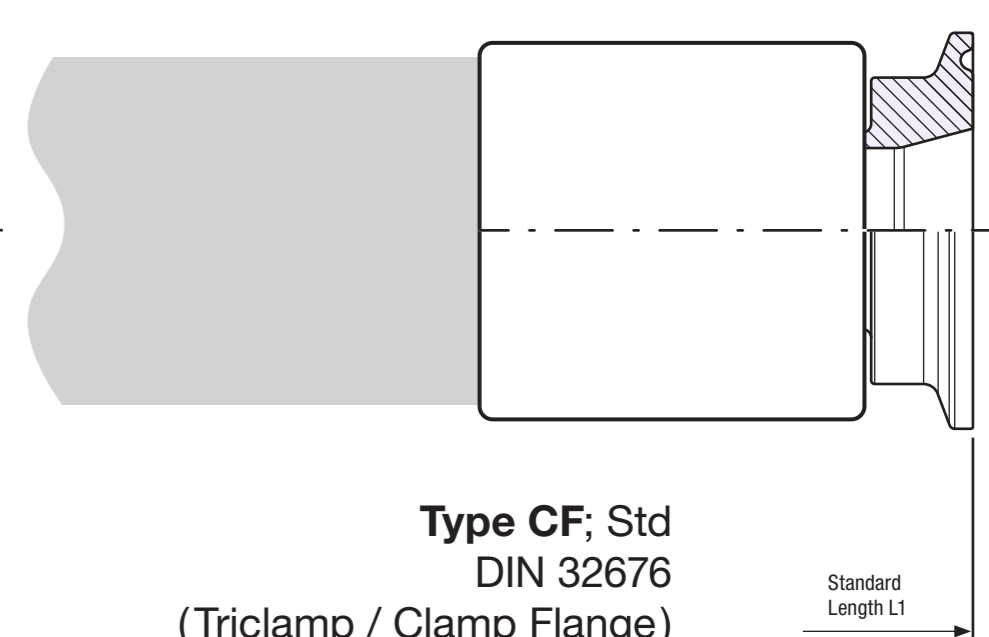

**Type CF; Std**  
DIN 32676  
(Triclamp / Clamp Flange)

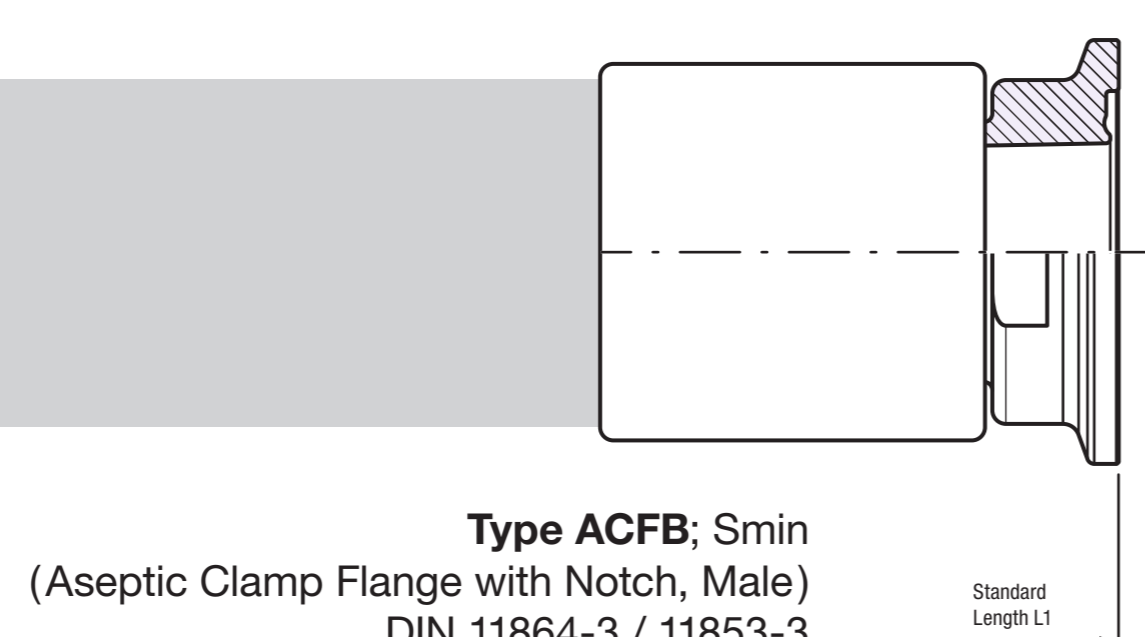

**Type ACFB; Smin**  
(Aseptic Clamp Flange with Notch, Male)  
DIN 11864-3 / 11853-3

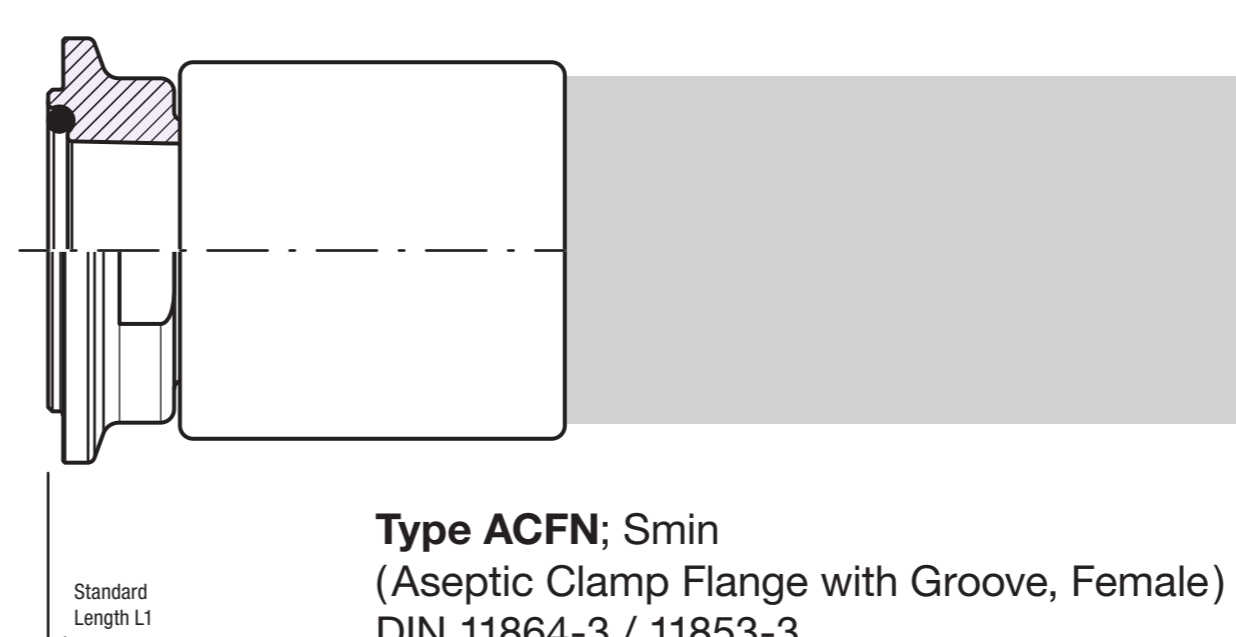

**Type ACFN; Smin**  
(Aseptic Clamp Flange with Groove, Female)  
DIN 11864-3 / 11853-3

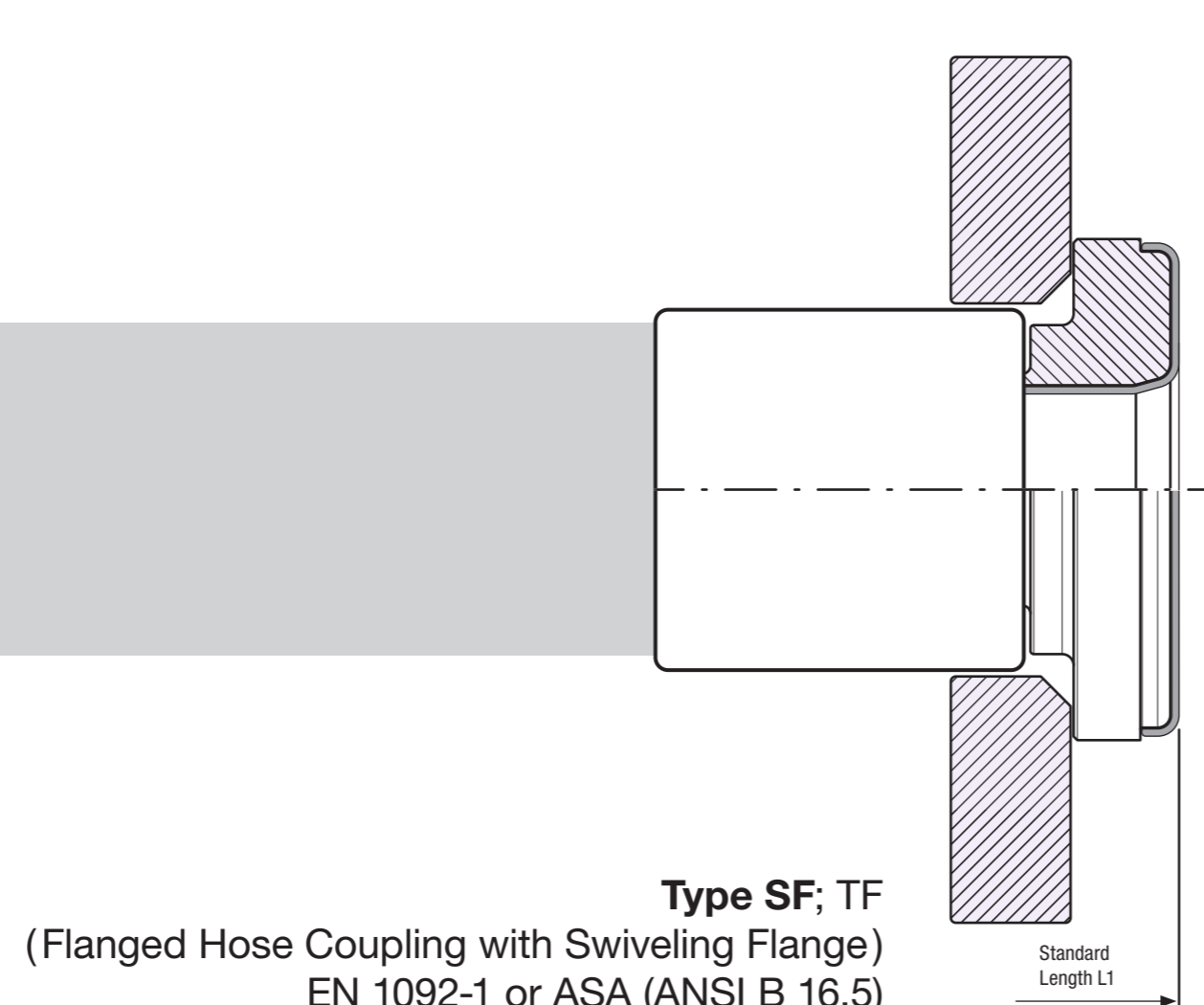

**Type SF; TF**  
(Flanged Hose Coupling with Swiveling Flange)  
EN 1092-1 or ASA (ANSI B 16.5)

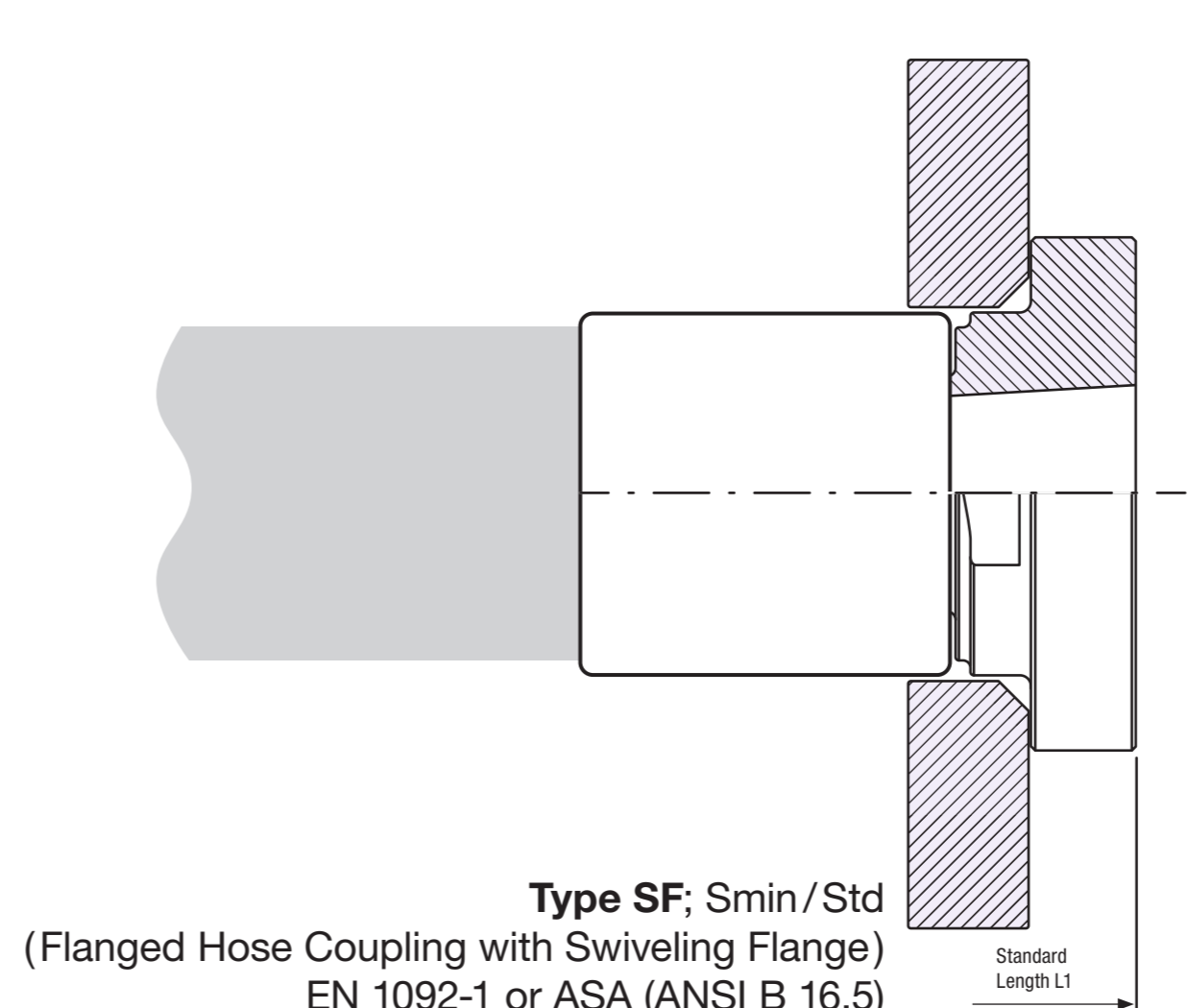

**Type SF; Smin/Std**  
(Flanged Hose Coupling with Swiveling Flange)  
EN 1092-1 or ASA (ANSI B 16.5)

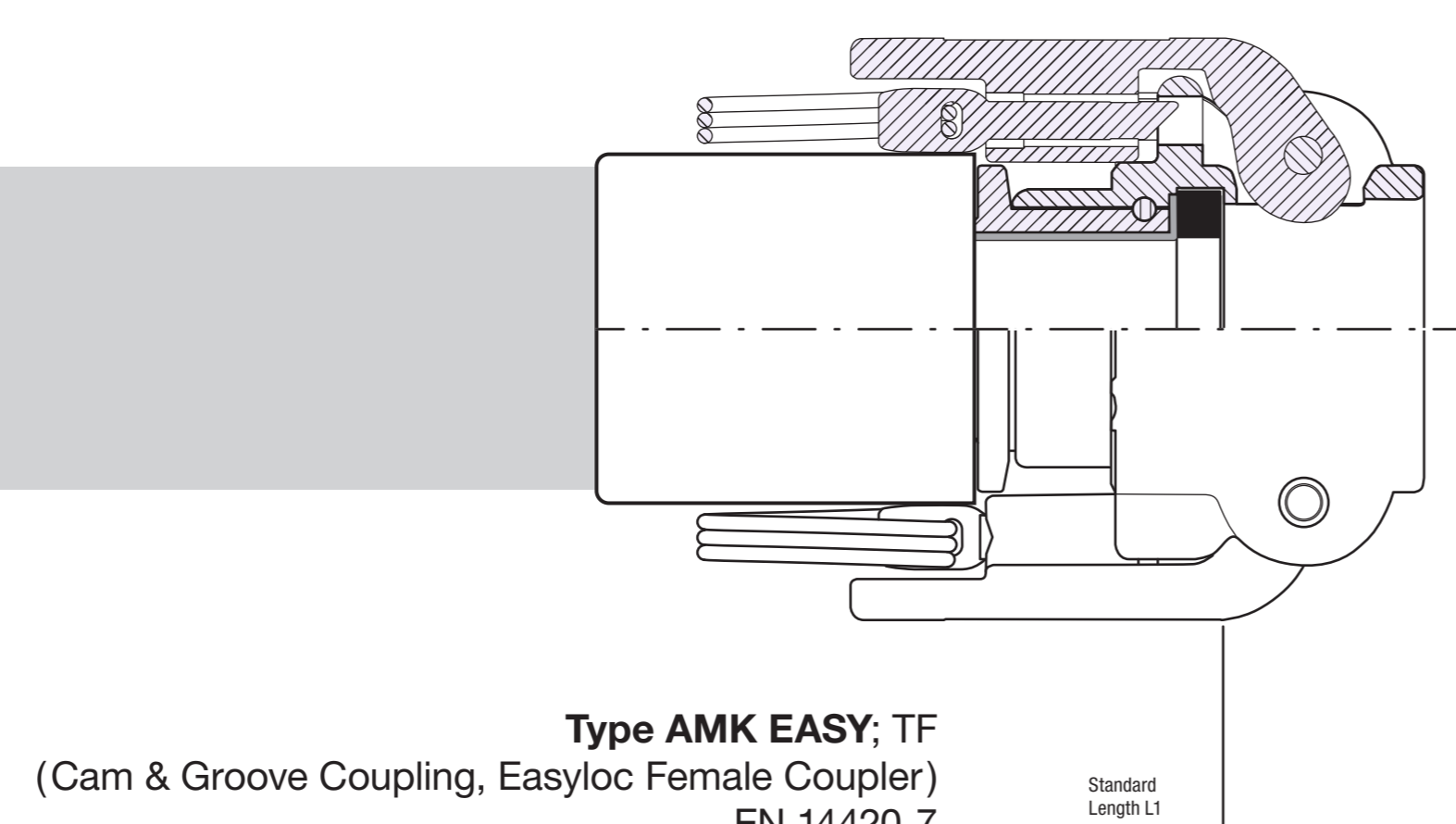

**Type AMK EASY; TF**  
(Cam & Groove Coupling, Easyloc Female Coupler)  
EN 14420-7

Crimping 'free of dead spaces / flared'	Crimping 'gap minimised'	Crimping 'standard'
<b>'TF'</b>	<b>'Smin'</b>	<b>'Std'</b>
<p>Crimped hose coupling, PTFE lining flared over ends. Patented process. No entrapment, use for highest media purity requirements.</p> <p>Usually used with DIN 32676 (Triclamp), DIN 11851 (Dairy Coupling) or flanged hose couplings.</p> <p>Materials: Coupling stainless steel 1.4404, Crimping ferrule 1.4301</p>	<p>Crimped hose coupling with flush-mounted hose tail. No obstruction of inner cross-section, almost no gap or dead volume between lining and hose tail.</p> <p>For high purity requirements. Suitable for all coupling types.</p> <p>Materials: Coupling stainless steel e.g. 1.4404, Crimping ferrule 1.4301</p>	<p>Crimped standard hose coupling.</p> <p>Choice of couplings according to EN 14420 or foodstuff and pharmaceutical couplings such as DIN 32676, DIN 11851, DIN 11864 or flanged couplings.</p> <p>Materials: Coupling stainless steel e.g. 1.4404, Crimping ferrule 1.4301</p>