

# PRODUCT GUIDE

Hoses | Couplings | Expansion Joints  
Nozzles | Hose Reels

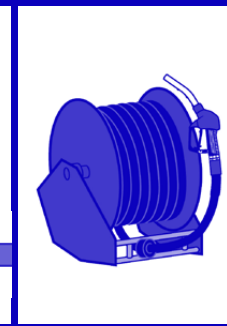
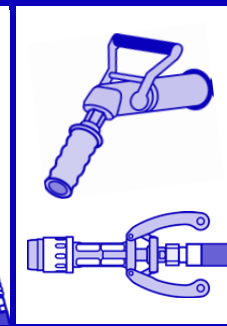
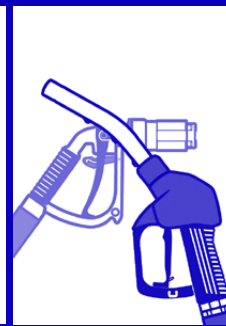
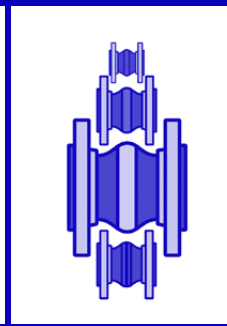
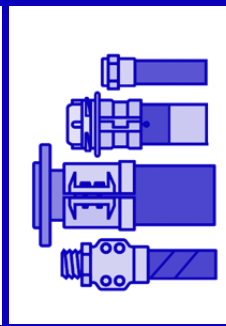
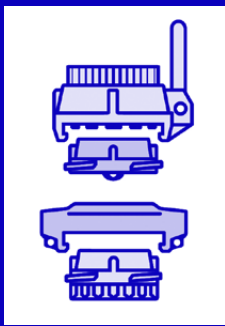
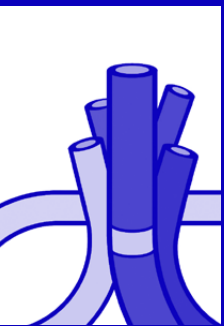

Quality hoses by ELAFLEX/ContiTech, setting the standards. Available as reel, cut lengths or assemblies.

## Aircraft Refuelling Hoses (EN ISO 1825, EI 1529)

'YELLOW BAND', types HD-C, VHD, PHD, TW-E. Suitable for all aviation fuels. Optional with NEON bands for improved visibility. Specified by all major oil companies. Lining NBR. Max. working pressure 20 bar.



## Universal Tank Hoses (EN 12115)

'BLUE-WHITE-BLUE', type UTD 13-38 without helix, type UTS 19-150 with helix. Suitable for most chemicals, petroleum based products and solvents. Lining UPE white with patented OHM conductive stripe. Max. W.P. 16 bar.

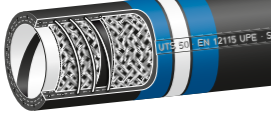

## Corrugated Tanker Hoses (EN 12115)

Good flexibility due to corrugations in the cover: Type LTW 50-100 for petroleum products (NBR lining), type UTL 38-100 universal hose (UPE lining). Max. W.P. 10 bar. Also available type LG, lightweight gravity discharge road tankers hose.

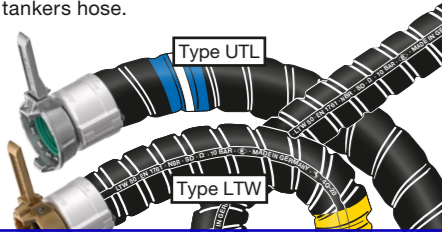

## Composite Hoses (EN 13765)

Type FWS (PP, PTFE, PA, VR), flexible general purpose hose for most common chemicals. Temperature range -30°C to +100°C. Max. W.P. 14 bar.

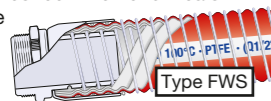

## Chemical Hoses (EN 12115)

'LILAC BAND', type CHD 13-50 without helix, CHS 25-150 with helix. Suitable for more than 75% of all industrial chemicals. Lining EPDM. Max. W.P. 16 bar (DN 150: 10 bar).



## Solvent Hoses (EN 12115)

'BLUE BAND', type LMD 9-25 without helix, LMS 25-150 with helix. For most solvents and paints, also water based. Lining NBR 2 blue, electrically conductive. Max. W.P. 16 bar (DN 150: 10 bar).



## Fuel Reeling Hoses without Helix (EN 1761)

'YELLOW BAND', type HD 10-100 without helix, for reel operation. Suitable for petroleum based products. Lining NBR. Max. W.P. 25 bar (DN 100: 20 bar).



## Tank Truck Hoses (EN 1761)

'YELLOW BAND', type TW 19-100 and type STW 125-200 with helix. Suitable for petroleum based products. Lining NBR. Max. W.P. 20 bar (> DN 100: 15 bar).



## ELAFLO PLUS FEP (EN 12115)

Type FEP 13 D without helix, FEP 19-100 with helix. Universal hose with seamless FEP lining for all standard chemicals. DN 13-50 with light grey cover and OHM-conductive spiral, DN 63-100 with black cover. Max. W.P. 16 bar.

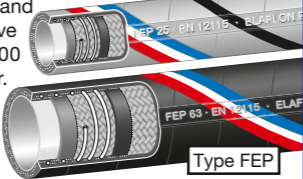

## ELAFLO PTFE (EN 12115)

Type PTFE 13 D without helix, PTFE 19-100 with helix. Universal hose for all commonly used chemicals. OHM-hose with electr. conductive, seamless lining of PTFE. FDA/USP Class VI. Max. W.P. 16 bar.



## FLUORFLEX 2

Ultra-flexible universal hose with helically wound PTFE lining for petrochemical, pharmaceutical and food industry. Temperature range -20°C up to +150°C. Max. W.P. 16 bar.



## POLYPAL® CLEAN (EN 12115)

Type PCD 13-19 without helix, PCS 25-100 with helix. 'Clean' universal hose for almost all fluids. Lining UPE bright with conductive spiral stripe. Cover EPDM light grey with OHM-conductive spiral. Max. W.P. 16 bar.

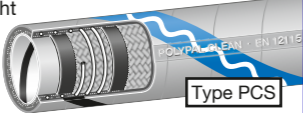

## Pharma Hoses (Liner FDA / USP Class VI conform)

ELAPHARM hose assemblies for highest media purity requirements, with PTFE lining. Type EPH (blue cover, el. isolating) and EPH-OHM G (light grey cover, el. conductive) DN 13-50 with crimped connections, also free of dead spaces.



## Bunkering Hoses (EN 1765)

Type FHD 75-250, collapsible marine bunkering hose without helix. Suitable as pressure hose for petroleum based products. Max. W.P. 15 bar



## LPG Hoses (EN 1762)

'ORANGE BAND', type LPG 10-200 without helix and LPG 10-200 with helix. Also as special types LPG 16S & LPG 16 for Autogas dispensers. For propane, butane and other L.P. gases. DVGW-approved. Lining NBR. Max. W.P. 25 bar.

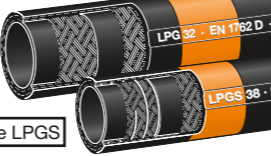

## Hot Bitumen Hoses (EN 13482)

Type HB 50-100 with helix. Suitable for hot bitumen and heavy fuel, -25°C up to +200°C. Lining special elastomer. Max. W.P. 7 (10) bar.

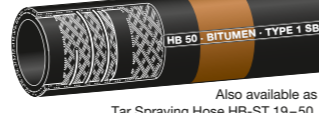

## Steam Hose (EN ISO 6134)

Type SD 13-50. Suitable for wet saturated steam (+210°C) max. W.P. 18 bar and hot water up to +120°C. For cold water max. 25 bar. Lining EPDM.



## Ammonia Hose

Type AMX 13-50. For ammonia. Max. W.P. 25 bar. Lining EPDM.

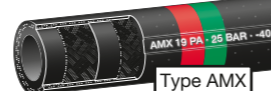

## Hydrogen Hose

Type H2 13-50 D without Helix, type H2 25-50 S with helix. Connecting hose for gaseous hydrogen. Lining black, smooth, cover electrically conductive. Temperature range -40°C up to +65°C. Max. working pressure 60 bar. Burst pressure > 120 bar.  $\Omega/T$  hose, suitable for all Ex-zones. Permeation rate per metre <math> < 1 \times 10^{-4} \text{ mbar} \cdot \text{l/s} < /math> (<math> < 0.36 \text{ Ncm}^3/\text{h}< /math>). Suitable for wet and dry hose systems.

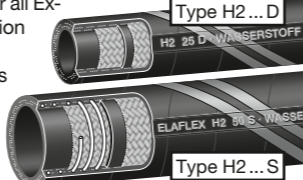

Safe and secure connections.

## Hose Couplings Ferrule Type (EN 14424)

Female/male hose couplings (ferrule type) with union nut, DN 13-25. Brass, also chrome plated or stainless steel. Also available as non-reusable type NR. Max. W.P. 25 bar.

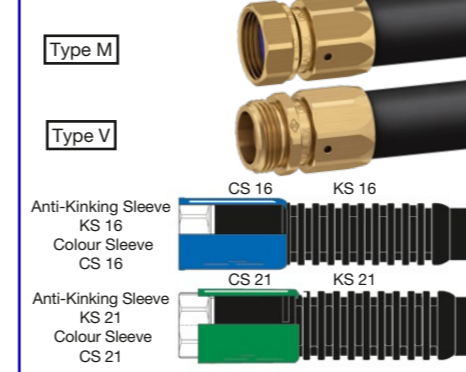

## Food + LPG Hose Couplings (DIN 11851, EN 14422)

Hose couplings of stainless steel with special thread for foodstuffs max. W.P. 16 bar. Hose couplings brass/steel with ACME thread for LPG max. W.P. 25 bar. SPANNFIX or SPANNLOC clamps.



## 'TW' Hose Couplings (EN 14420-6)

'TW' hose couplings, one piece or two piece coupler, with SPANNFIX or SPANNLOC clamps. Max. working pressure 16 bar.



## 'Storz' Hose Couplings (DIN 14301)

'STORZ' hose couplings of aluminium. SPANNFIX or SPANNLOC clamps. Max. W.P. 10 bar.



## SPANNFIX Hose Couplings (EN 14420-5)

Female/male hose couplings with reusable SPANNFIX pinned safety clamps of hot stamped aluminium. DN 19-100. Max. working pressure 25 bar.

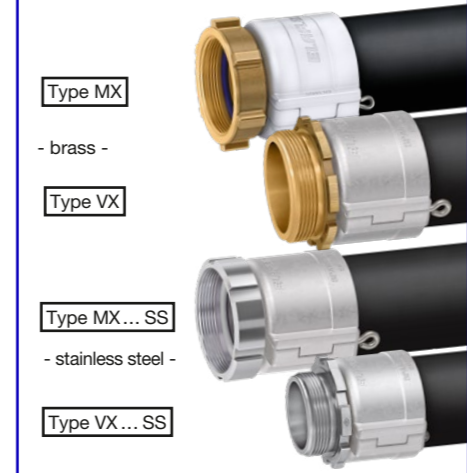

## SPANNLOC Hose Couplings (EN 14420-5)

Female/male hose couplings with reusable SPANNLOC bolted clamps of hot stamped aluminium. DN 13-100. Max. working pressure 25 bar.

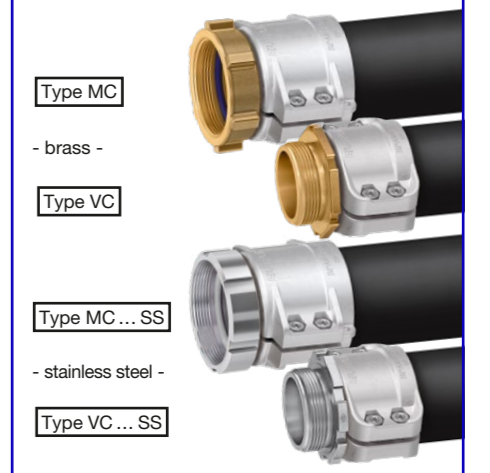

## Steel Hose Couplings (EN 14420-5)

Female/male hose couplings of steel, zinc plated and chromated. For LPG, hot water and mechanical engineering applications. Max. working pressure 25 bar. SPANNFIX or SPANNLOC clamps.



## Hose Couplings for Steam (EN 14423)

Male/female hose couplings with bolted clamps of stainless steel or hot stamped brass. Hose tail and union nut either of stainless steel, steel zinc plated + chromated or brass. Suitable for saturated steam up to +220°C, ammonia (stainless steel only) and compressed air. Max. W.P. 25 bar.



## Clamp Hose Coupling 'Tri Clamp' (DIN 32676)

Clamp hose coupling 'Tri Clamp' of stainless steel, with ferrules. Application for food, chemical, cosmetic and pharmaceutical industries. Available with working pressure of 10, 16 and 25 bar.



## Cam Locking Couplings (EN 14420-7)

'Camlock' hose couplings of brass, aluminium or stainless steel. With SPANNFIX or SPANNLOC clamps. Max. W.P. 16 bar (DN 100: 10 bar).



## Flanged Hose Couplings (EN 1092-1, EN 14420-4/14423)

Swiveling or fixed flanges, SPANNFIX or SPANNLOC clamps.

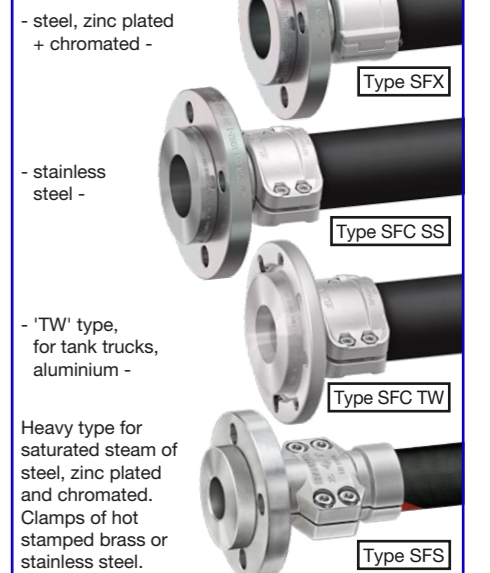



## Tank + Pipe Couplings

Safe and secure connections.

### 'TW' Couplings (EN 14420-6, DIN 28450)

Quick couplers to EN 14420-6. One hand tightening without tools, safe and leak-free connection. For tankers and industrial applications. Sizes 2", 3" und 4". Of hot stamped brass, stainless steel or hot stamped aluminium. Dust plugs also of polyamide. Max. working pressure 16 bar.

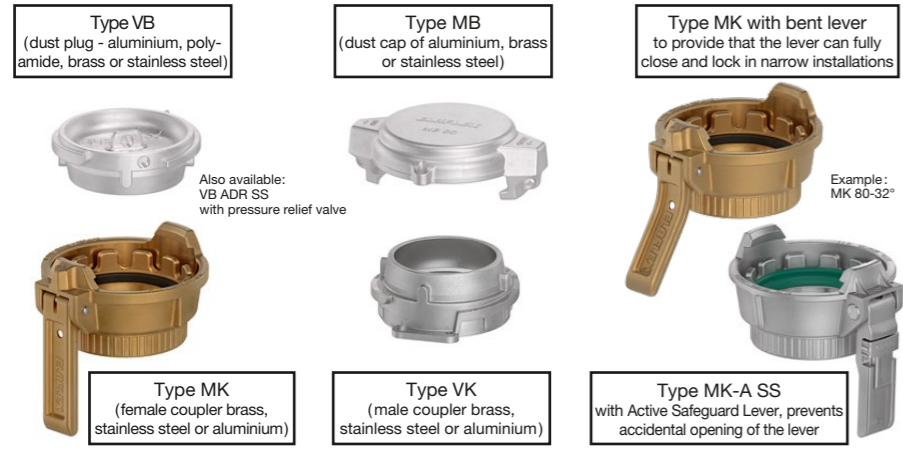

### Accessories for Rail Tankers

Rail tanker adapter type KWZ, one end with rail tanker thread 5 1/2", other end male thread BSP or quick coupling. Rail tanker discharge coupling type KWK with male thread or quick coupling.

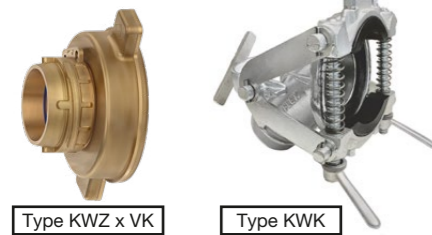

### Sight Glasses

Sight glasses type SG (with BSP thread EN ISO 228). Type TSG (one side with tank truck flange). Brass also chrome plated, or aluminium.



### Swivels

Swivel hose inlets to avoid torsion of hose assemblies. DN 25-50, of brass or stainless steel. Max. W.P. 10 bar.



### Pipe Connectors

Flexible bronze pipe connectors with swiveling oval flanges. Suction service between dispenser + storage tank, max. vacuum 0,9 bar. Type BWO standard. Type KW: with cathodic protection.



### Cam Locking Couplings (EN 14420-7)

Female or male couplings, dust caps and dust plugs, DN 13-100, of stainless steel, brass or aluminium. Max. W.P. 16 bar (DN 100: 10 bar).

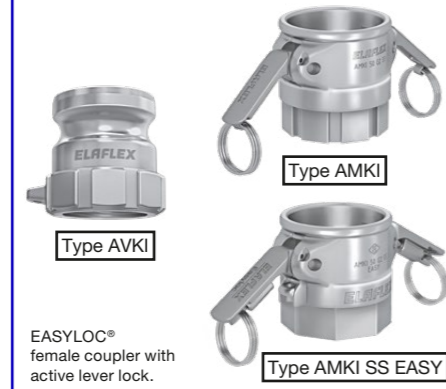

### Symmetrical Couplings (EN ISO 228/EN 14420-8)

Fixed couplings 'Storz' or 'Guillemin', with BSP thread. All standard sizes of brass, aluminium or stainless steel. Max. working pressure 10 bar.



### ELAPAC-FD

Flange sealing material free of plasticisers. Suitable for tank truck and tank installations, for petroleum based products and many other media. Available as cut seals, sheets or coils.

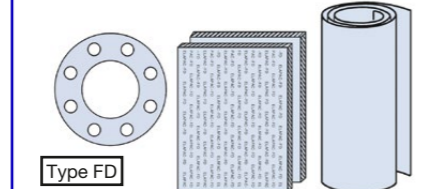

### Teflon® PFA Coating

Stainless steel threads, flanges and couplings also available with additional Teflon® PFA coating (FDA compliant) on surfaces in contact with medium, for specially aggressive media (e.g. hydrochloric acid, ferro-III-chloride, diluted sulfuric acid). Colour: red.



### Dry Disconnect & Breakaway Couplings

Self-locking couplings, MannTek brand. For liquid media or liquefied gas. Can be coupled up to 7 bar. Brass/bronze, stainless steel or aluminium. Max. W.P. 25 bar (16 bar for aluminium). Also available with selectivity system or flanged type.

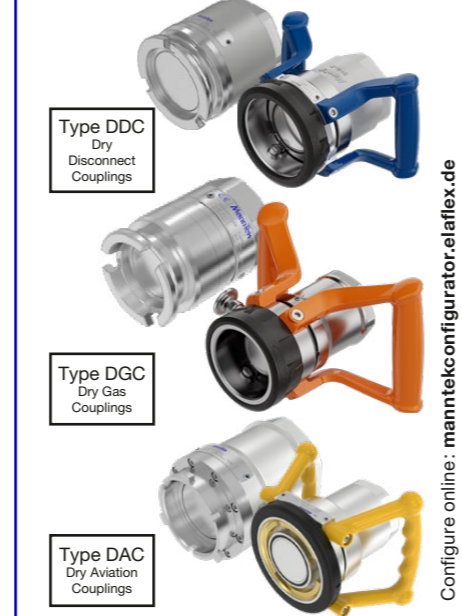

Also available:  
- 'SBC' Breakaway Couplings for all liquid media  
- 'DCC' Dry Cryogenic Coupling & 'CBC' Breakaways

### Flanges

Flanges to EN 1092-1 with male thread, short or long design. Of steel, stainless steel, brass or aluminium.



Tank truck welding flanges TFA with rim (also available in space saving square shape TQFA). Type TF without rim. Made of steel or stamped aluminium.



Tank truck flanges TGN, with threaded nipple, to DIN 28462. Of aluminium, brass or stainless steel.



## Rubber Expansion Joints

ERV high quality expansion joints DN 25-1000 by ELAFLEX/ContiTech. With swiveling flanges (various types and materials).

### ERV-R

RED BAND expansion joint for water, drinking water, waste water, seawater, cooling water, chemical waste water (without oil), chemicals, acids and alkalis, salt solutions, alcohols. Temperature range -40°C up to +100°C, temporarily up to +120°C. Lining Butyl/EPDM.



### ROTEX

ROTEX expansion joint for permanent service with hot heating water, cooling water and hot air. Max. W.P. 10 bar up to +100°C, 6 bar up to +110°C. Temperature range -40° up to +130°C, temporarily up to +150°C. TÜV approved, DIN 4809. Lining EPDM.



### ERV-CR

CR expansion joint for cold and warm water, seawater (also oil containing), various waste water, lube oils and greases, air, compressed air. Temperature range -25°C up to +90°C, temporarily up to +100°C. Lining Chloroprene.



### ERV-BR

BLUE SPOT expansion joint for abrasive media, sludges, slurries, solid/liquid mixtures and emulsions, dustlike or powdery products. W.P. max. 16 bar. Temperature range -50°C up to +70°C, temporarily up to +90°C. Lining BR/NR.



### ERP

RED SPOT expansion joint for sanitary installations, cold/warm water, swimming pool water, seawater, drinking water. Highly flexible + low own resistance. Max. W.P. 10 bar. Temperature range -40°C up to +90°C, temporarily up to +120°C. Lining Butyl/EPDM.



### ERV-G

YELLOW BAND expansion joint for petroleum based products up to 50% aromatics, fuels, aviation fuels, town gas and natural gas. Temperature range -20°C up to +90°C, temporarily up to +100°C. Lining NBR.



### ERV-G AF

Special type ERV-G AF expansion joint for aviation refuelling or dispensing vehicles in accordance to EN ISO 1825/EI 1529. Suitable for all aviation fuels. Temperature range -40°C up to +65°C. Max. W.P. 20 bar.



### ERV-GS

YELLOW STEEL expansion joint. Similar to type ERV-G, but fire resistant to ISO 15540 (type approved). Also for cooling water emulsions with oily anticorrosion additives. Temperature range -20°C up to +90°C, temporarily up to +100°C. Lining NBR.



### ERV-GS HNBR

YELLOW STEEL HNBR expansion joint for petroleum based products up to 50% aromatics and hydraulic oil. Also for cooling water emulsions with oily anticorrosion additives. Large temperature range -35°C up to +100°C, temporarily up to +120°C. Lining HNBR.



### ERV-G LT

YELLOW BAND LT expansion joint designed for low temperature applications for standard-conform petroleum based products. Temperature range -40°C up to +90°C, temporarily up to +100°C. Lining NBR.



### ERV-OR

ORANGE BAND expansion joint for Liquid Petroleum Gas (LPG) to EN 589. Temperature range -20°C up to +90°C, temporarily up to +100°C. Max. W.P. 25 bar. Lining NBR.



### ERV-GR

GREEN BAND expansion joint for chemicals, acids, alkalis and aggressive chemical waste water. Temperature range -20°C up to +100°C, temporarily up to +110°C. For oil-contaminated compressor air up to +90°C. Lining CSM.



### ERV-W

WHITE BAND expansion joint for foodstuffs, also containing oil and fat. Lining conform to rec. XXI of BfR and FDA-21CFR 177.2600. Temperature range -20°C up to +90°C, temporarily up to +100°C. Lining NBR, light grey.



### Accessories





Nozzles by ELAFLEX HIBY: ergonomic design, long life, fully serviceable.

## ZVA Slimline 2 (EN 13012, ATEX)

Automatic nozzle for flowrate up to 80 l/min. Suitable for gasoline, also with ethanol content, diesel, fuel oil and biodiesel. Working pressure 0,5 – 3,5 bar.



## ZVA 25 (EN 13012, ATEX)

Automatic nozzle for flowrate up to 140 l/min, DN 25. Suitable for gasoline, diesel and fuel oil. Working pressure 0,5 – 3,5 bar.



## ZVA 32 (EN 13012, ATEX)

Automatic nozzle for flowrate up to 200 l/min, DN 32. Suitable for diesel, light fuel oil, petroleum, AVGAS and Jet fuels. W.P. 1,5 – 6 bar.

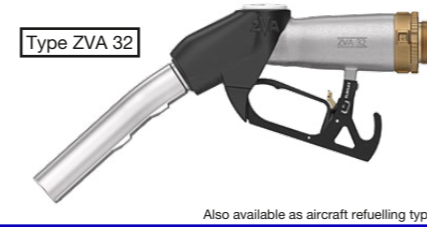

## ZVA Slimline 2 GR (EN 13012, ATEX)

Automatic nozzle for active vapour recovery. Suitable for all standard gasoline fuels (also with ethanol content), up to 45 l/min. Design 'GRV' with integrated vapour valve 'On/Off', Design 'GRVP' with vapour proportional valve. Working pressure 0,5 – 3,5 bar.



## Corrosion Resistant Automatic Nozzles

Automatic nozzles in special construction of gunmetal (ZVA-RG) or bronze (ZVA-GBZ). Suitable for solvents, alcohols and chemicals.



## ZV 19 / ZV 25

Nozzles without automatic shut-off function for gasoline, diesel, fuel oil and vegetable oil. ZV 19 (DN 19) up to 100 l/min; ZV 25 (DN 25) up to 140 l/min. Max. W.P. 3,5 bar. Special types for chemicals available.



## ZVA for AdBlue® (EN 13012, ATEX, DEF, ARLA 32, AUS 32)

Automatic nozzle ZVA AdBlue HV (heavy vehicle) for urea solution (AdBlue®, DEF). Flowrate up to 40 l/min. Working pressure 0,5 – 3,5 bar. Spout with magnet opening; refuelling only possible with ELAFIX 40 magnet adapter within vehicle filler neck.



ZVA AdBlue LV for Light Vehicles <3,5t. Up to 10 l/min. W.P. 1,5 – 3,5 bar.

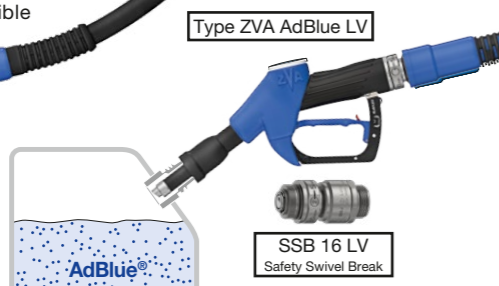

## Bulk Delivery Nozzles

Fuel oil nozzles without automatic shut-off function, DN 32 – 50, types ZV 400, ZV 500 and ZH 50. Available either with fixed spout or TW coupling. Flowrates 250–650 l/min. Max. W.P. 10 bar.

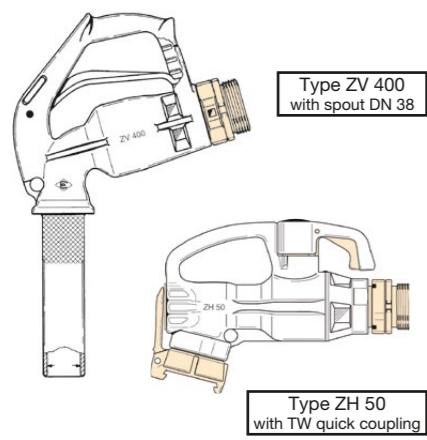

## Nozzles for Aircraft Refuelling

Nozzles with or without automatic shut-off function for over-wing refuelling. Suitable for AVGAS and JET fuels. Flowrates: ZVF 25 and ZVA 25 AF up to 140 l/min, ZVA 32 up to 200 l/min, ZVF 50 up to 400 l/min.



## Petrol Pump Hoses (EN 1360, EN 13483)

Quality petrol pump hoses 'SLIMLINE' DN 16–25 for gasoline and diesel fuels, also with biodiesel or ethanol content. Cold flexible down to -30°C (LT-type down to -40°C). Assembly with ferrule type couplings. Max. W.P. 16 bar.



High quality solutions.

## Safety Breaks, Sight Glasses (EN 13617-2, ATEX)

Self-closing safety break couplings for nozzles, reusable. To protect dispensers, hose assemblies and cars in case of drive-off incidents.



## LNG Nozzle, Couplings and Hoses

LNG Refuelling System of heavy vehicles (trucks) for petrol station forecourts meets the highest safety and quality standards.

Consisting of:

- N-LNG Nozzle with filling point to EN ISO 12617.
- VC-LNG Vent Coupling for overpressure regulation (> 10 bar) in the LNG tank to enable refuelling.
- LNG 25 Fill Line Assembly for nozzle. LNG 13 Vent line Assembly for vent coupling.
- SB-LNG reusable Safety Breaks for Fill and Vent Lines with different connections.

For use with Liquefied Natural Gas (LNG) or liquid nitrogen for calibration purposes with a low media temperature down to -196°C. Flow rate up to 190 l/min (50 GPM). Maximum working pressure 34 bar. Ambient temperature range -40°C to +85°C (-40°F to +185°F).

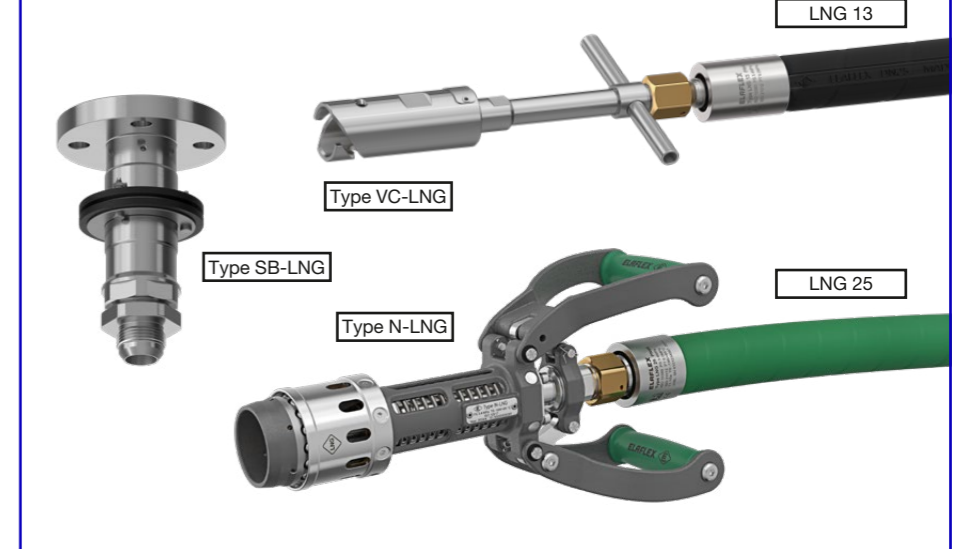

## LPG Nozzle, Accessories (EN 13670, ISO 19825, ATEX)

Autogas (LPG) nozzle with ACME, DISH, EURO, DME and K coupling. For propane, butane and mixtures up to 50 l/min. Max. W.P. 25 bar.

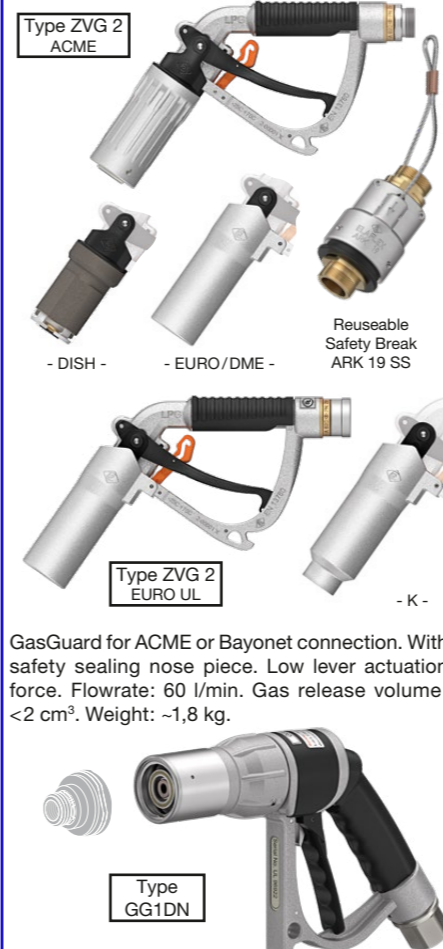

## CNG Nozzles, Valves, Couplers, Safety Breaks

CNG components are used in the gas energy and transport industry to handle greater volumes, higher pressures and tough reliability requirements. To minimise the risks of fuel storage and dispensing with CNG and other compressed technical gases such as Biogas, Air, Nitrogen, Helium or Hydrogen. The components comply with PED 2014/68/EU. The most of CNG products are designed for working pressures up to 410 bar (6000 psi), the nozzle N-CNG P30 (Standard EU) to 207 bar (3000 psi), N-CNG P36 (Standard US) up to 250 bar (3600 psi).

The Ultra Fast Fill system includes:

- Ball Valves
- Check Valves
- Quick Couplers
- Safety Breaks such as SB-CNG
- Fill Valves and Nozzles such as N-CNG
- Manifolds

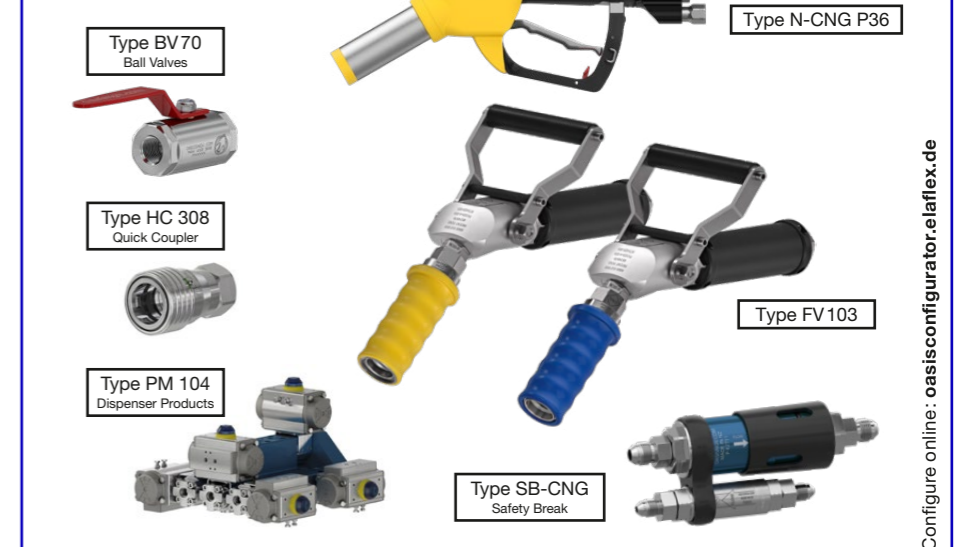

Configure online: oasisconfigurator.elaflex.de



Customised, complete solutions by ELAFLEX.

## Custom-Made Hose Reels (ATEX-conform)

'HR' Hose Reel Packages optional with hoses, couplings and nozzles. Delivered as complete tested system. Commonly used for trucks, marina, ports (terminals) and ships, depots, petrol stations or airports. Suitable for a wide range of media, e.g. gasoline, diesel, Jet fuels, AVGAS, urea solution (AdBlue®), detergents, disinfectants, solvents, oils, water and gases.

For reliable and safe transfer of liquids or refuelling of land, water and air vehicles – even under challenging conditions. Suitable for all common fuels as well as a variety of sensitive, aggressive, corrosive, flammable and explosive media.

Installation on plain or vertical surfaces (without further modifications).

Supplied with different rewind systems.

**HR 'Compact Line'** with spring rewind system and integrated static hose guide as standard.

**HR 'Modular Line'** with various rewind systems such as manual, electric, hydraulic or pneumatic.

Type HR  
'Compact Line VR'



Type HR  
'Modular Line'  
Hydraulic Rewind



Type HR  
'Modular Line'  
Manual Rewind

## Storage Hose Reels

For a safe and clean storage only. Suitable for hoses DN 13 to DN 250. Rewind systems as manual, electric, hydraulic or pneumatic available.

Type HR  
'Storage Reel'



## Bonding Reels

Bonding Reel with spring rewind system. For earthing and bonding with highly visible bonding cable, up to 30 m, Ø 5,5 mm, different types of clamps.

Type HR  
'Bonding Reel'



This brochure shows only a small part of the Elaflex product range. Further information from our distribution partners or from:

ELAFLEX HIBY GmbH & Co. KG

Schnackenburgallee 121  
22525 Hamburg/Germany

Tel.: +49 40 540 005-0

E-Mail: info@elaflex.de

Internet: www.elaflex.com